

Non Destructive Examination of PE Welds – Emerging Techniques

The purpose of this Technical Note is to provide information relating to the emerging technologies that are being developed to non-destructively examine welds in polyethylene (PE) pipe systems. Before proceeding any further there are some critically important facts that must be understood:

- At the time of writing this document in 2014 – No volumetric non-destructive testing (NDT) technique had advanced to a stage where standards or acceptance criteria had been developed.
- Close visual inspection remains one of the most effective and most reliable non-destructive examination techniques for PE welds.
- NDT will never be a substitute for diligence in following weld procedures.

There is however, a great deal of activity in this area around the world and some technologies show significant promise that in time will offer reliable and quantifiable means of non-destructively examining PE welds volumetrically in a similar manner to metallic systems.

It is also worth noting that many people have been conditioned to relying on radiography or ultrasonics in traditional metal welding and the value of visual examination of PE welds is often underestimated by this group. The examination and testing of PE pipe welds has generally been based on visual and destructive testing options. These have proved very successful techniques for assessing welds along with a dedication to ensuring the correct surface preparation and weld procedures are employed. Visual examination of welds is a particularly useful NDT technique in the context of PE welding as it yields a great deal of information about the weld preparation, potential contamination, alignment and weld procedure in a manner that has no equivalent in metal welding.

This technical note will firstly consider the structured research being conducted in Europe and the US and will then provide a brief description of each of the most promising of the techniques. These structured projects are by no means the only activities in the area of NDT of PE welds but they represent significant approaches utilising multiple participants that in some cases at least are non-commercial in nature. There are multiple commercial projects also underway with individual companies exploring a variety of options. It is fair to say that most of the serious contenders in this area have narrowed their focus to techniques based on ultrasonics with phased array, chord or time of flight diffraction options and microwave technology. Beyond the techniques currently being considered there are potentially other variations based on other NDT techniques used by industry and for medical imaging that may prove suitable in the future. For the purposes of this paper we have restricted comments to the current suite of techniques showing the most promise and also those which are becoming commercially available.

STRUCTURED RESEARCH IN EUROPE

GERG PROJECT

KIWA Gas Technology in the Netherlands as part of a European Gas Research Group (GERG) Project conducted a series of comparison tests looking at the performance of Time of Flight Diffraction (TOFD), Microwave and Phased Array techniques concentrating on butt welds and in particular looking for techniques that can identify welds where there is fusion (and hence no physical defect) but where the weld strength would be in question. They also included some assessment utilising the CHORD Ultrasonic technique and also the bead bend back test. The project looked at 180 weld samples where the outcomes from the non-destructive testing (NDT) options were subsequently compared to the findings from destructive examination and testing of the sample welds. Their initial results were published in 2012 and presented at the PIPESXVI conference the same year. The paper is titled *"Suitability of non-destructive techniques for testing polyethylene pipe joints"* Peter J. Postma, René J.M. Hermkens, Kiwa Technology, The Netherlands. (1)

The paper concluded the techniques being evaluated showed significant promise but needed further development particularly in the aspect of pass/fail criteria as the TOFD and Microwave techniques resulted in high "false positive" outcomes. Both these techniques performed better with butt welds than electrofusion (EF). The Microwave technique was noted as requiring significant development in the context of EF weld evaluation. There was insufficient testing of the CHORD technique to draw any real conclusions but they noted it was promising.

During the presentation at the PIPESXVI conference the author made the additional observation (not included in the written paper) that good visual examination would yield outcomes at least as good as those achieved by any of the techniques.

THE TEST PEP PROJECT

The TestPEP project is a €3.5m European Union funded program with the aim of designing, manufacturing and validating a phased array ultrasonic testing system to inspect butt and electrofusion welds. The project is expected to take around 3 years and be completed in 2014 (at the time of preparing this document there were no published final results). It involves 17 organisations across 5 European countries and includes organisations like The Welding Institute in the UK, Hessel in Germany, M2M in France, E-On Gas and British Energy.

Importantly this group is also interested in establishing the critical limitations for the size of defects that can be permitted in a weld. Whilst it is important to assess the effectiveness and sensitivity of the NDT techniques themselves it is equally important to determine the critical size of a defect where it reduces the quality and performance of the welded joint.

The work will be assessing measured defects using primarily phased array technology and comparing them to the known defects that have been created in the welds and also correlating these with mechanical test results. In 2012 they published a paper outlining the project and progress to that stage – the report is titled *Development of an automated phased array ultrasonic system and flaw acceptance criteria for welded joints in polyethylene pipes"* Mike Troughton, Malcolm Spicer and Fredrik Hagglund, TWI Ltd.

STRUCTURED RESEARCH IN THE UNITED STATES

The work in the US is being driven largely by the demands of the nuclear power industry. Many of the nuclear power plants in the US are either in the process of, or approaching major refits. One very significant area of concern for this industry has been the corrosion of steel cooling water pipelines. PE offers the solution to these serious corrosion problems and given the nature and experience of this industry they are looking to the option of NDT to improve their confidence in welded pipelines.

The US is facilitating much of their work through the ASME Code Case where they aim to develop a comprehensive code of practice for PE in Nuclear Plants. The list of organisations involved is extensive and includes the Plastics Pipe Institute, Electric Power Research Institute, major raw material manufacturers like Chevron Phillips, pipe manufacturers and expert consultants. This is another comprehensive program with many well qualified and well-credentialed participants.

Like the Europeans they are correlating known flaws with the NDT results and also comparing them to mechanical test results. They are also looking closely at a variety of joint geometries for butt welds as the cooling water systems involve multiple fabricated fittings.

The Americans are looking at both TOFD and Phased array simultaneously and importantly are also heavily involved in determining the critical defect size. Whilst the Europeans are also investigating the threshold limits for defect size the Americans appear to be putting more effort into the fracture mechanics aspects associated with flaws having sharp edges.

Again, at the time of preparing this document we were not aware of any published outcomes from this work.

PROMISING TECHNIQUES

ULTRASONIC TESTING

Ultrasonic Testing (UT) of polyethylene materials is challenging due to high attenuation of the ultrasonic beam energy (i.e. the polymer absorbs nearly all sound energy, and reflects essentially none). PE material exhibits little anisotropy and no adjustment in sensitivity is required when testing in different directions. Acoustic velocity is dependent on temperature and hence cooling of welds to ambient conditions is required prior to inspection.

ASTM F600-78 Practice for Non-Destructive Ultrasonic Evaluation of Socket and Butt Joints of Thermoplastic Piping was published in 1983, however it was withdrawn in 1991 as results obtained using this standard were heavily dependent upon the skill of the operator.

Specialised polymer specific probes and more powerful/feature rich UT machines have been developed in the last 30 years leading to enhanced detection capabilities resulting from both stronger signal transmission and clearer signal interpretation and processing.

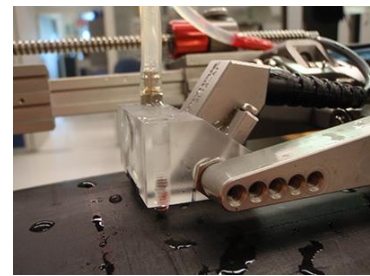
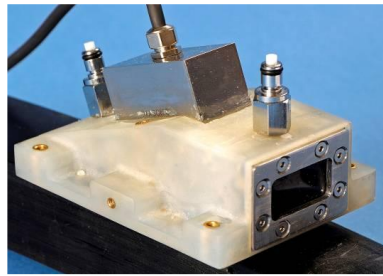
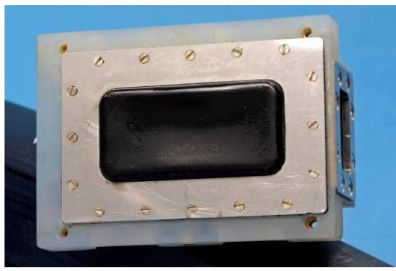

VARIOUS WATER COUPLED PROBES DEVELOPED FOR INSPECTING PE

Top images- "Plastic Fantastic? - An Nde inspection Solution For HDPE Butt Welds" D MacLennan, I G Pettigrew and Colin R Bird.
 Bottom image- <http://www.olympus-ims.com/en/Ultrasonic-phased-array-examination-butt-fusion-joints/>

BUTT FUSION (BF) AND ELECTROFUSION (EF) JOINTS

Whilst both producing a fusion zone between two plastic materials, differ markedly in their implementation. As a result, the inspection requirements and methods suitable for each jointing process will differ. A number of angled multi-probe/element solutions are evolving for the inspection of field joint. In most instances a selection of techniques are required to target defects across all regions within the weld. A range of these UT techniques and their application are discussed below:-

SINGLE PROBE PULSE-ECHO UT

Is capable of locating coarse inclusions or volumetric defects within the bulk pipe material, however geometric constraints require the removal of butt fusion weld beads to inspect the fused region. Even with the weld bead removed, 0° pulse echo probes are ineffectual at recording the perpendicular planar type defects which are common to butt fusion jointed regions such as cold welds. The pulse echo method has shown to be most suited for inspecting lack of fusion type defects within EF joints provided sufficient resolution for inspection between the wires is achieved.

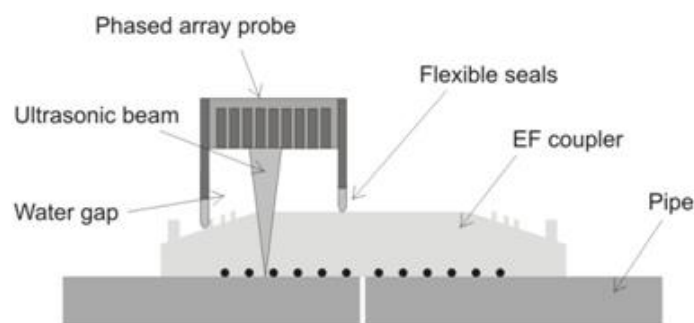

PULSE ECHO CONFIGURATIONS FOR THE INSPECTION OF EF JOINTS EMPLOYING 0° BEAM ANGLE

(Image from F. Hagglund, M. Spicer, M. Troughton "Development of Inspection Techniques for an Automated NDE Approach for Testing Welded Joints in Plastic PE Pipes,")

CHORD UT

Has shown promise for indicating BF joint integrity. The method operates through the projection of ultrasonic beams, reaching a defect (and reflected from it), on an axial plane of the welded joint which lie on a chord of a cross-section of the pipe. The CHORD scheme of inspection for the welded joints separates functions of transmitting and receiving of ultrasonic waves. The main parameters of transmission and receiving of ultrasound (the angles of input - receiving, angle between transducer

and receiver etc.) are selected in such a manner that the main energy of an emitted beam is concentrated in a working cross section of the welded joint. Due to this, the detection of various defects in any zone of the joint within the limits of a thickness of the welded pipes is possible. At this early stage of development it appears this technique lends itself to the inspection of butt welded joints of polyethylene pipelines with diameters from 63mm up to 315mm with wall thicknesses from 6mm up to 25 mm. (Dr. G. Giller, Dr. L. Mogilner "Ultrasonic Inspection of welded pipeline joints: new technologies and instruments Non-destructive testing", No.1, 2000. RAS, Ekaterinburg.) The images below are from the same reference.

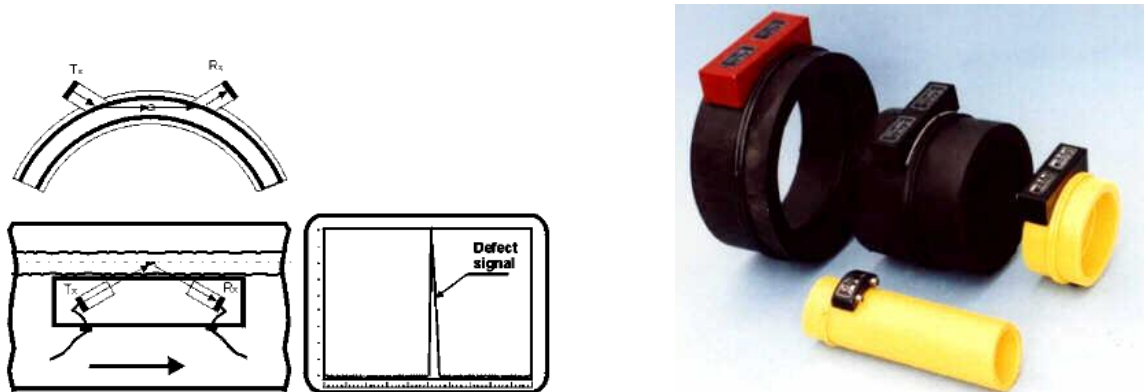

Inspecting BF joints to detect and image perpendicular planar flaws requires the use of angled ultrasound. There are four different angled techniques that can be used individually or in combination. The four techniques are self-tandem, sector pulse-echo, creeping wave and time-of-flight diffraction (TOFD). These angled UT inspection methods whilst proving suitable for BF joints have provided limited capability for the inspection of EF joints.

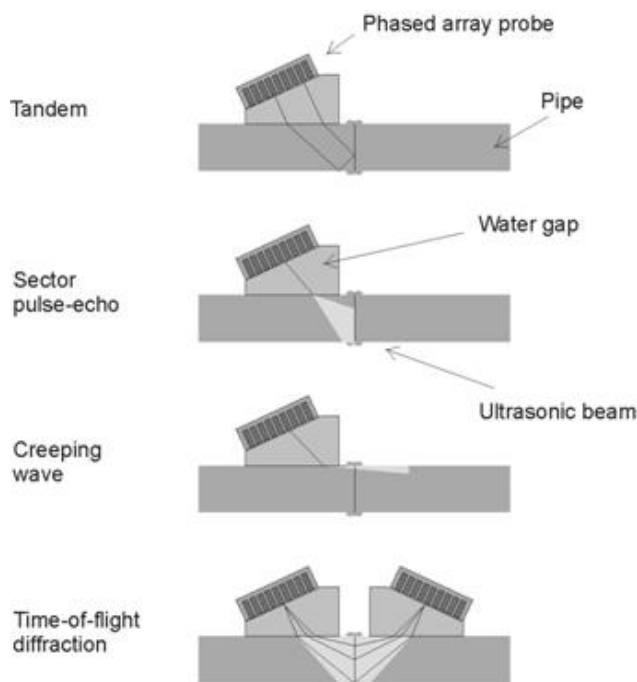

(Images from F. Hagglund, M. Spicer, M. Troughton "Development of Inspection Techniques for an Automated NDE Approach for Testing Welded Joints in Plastic PE Pipes.")

SELF-TANDEM UT

Utilises one half of the phased array elements for transmitting and the other half for receiving. The technique is good for detecting planar flaws but the coverage is restricted to an area closer to the inner surface.

SECTOR PULSE-ECHO UT

Utilises all of the elements in the probes array to create an aperture, sweeping the beam over a range of angles. The technique gives an overview of the weld and covers most of the fusion zone with the exception of a small region close to the outer surface.

ULTRASONIC CREEPING WAVES

Are used to inspect the fusion area immediately beneath the outer BF weld bead. The technique uses a high angle sector scan, producing compression waves propagating immediately under the inspection surface, to detect surface-breaking and near-surface defects.

TIME OF FLIGHT DIFFRACTION (ToFD)

Utilising a pitch-catch configuration covers the entire fusion zone and uses forward diffraction to detect vertical flaws.

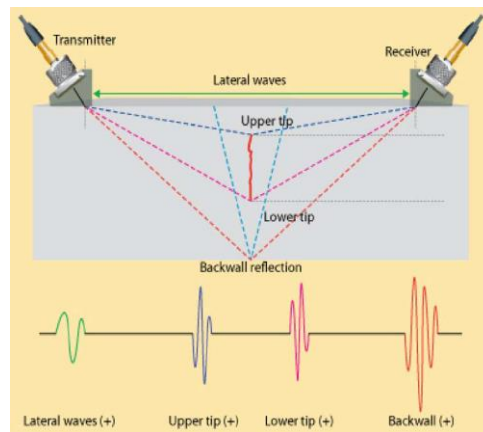
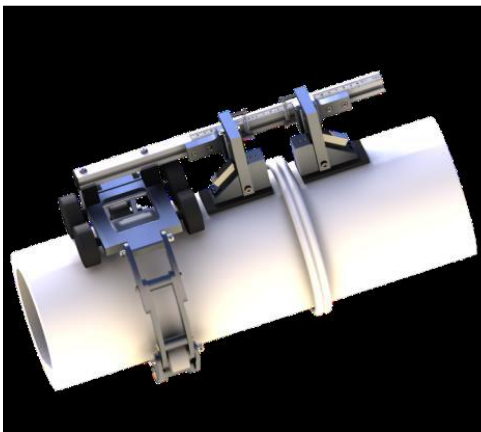

TIME OF FLIGHT DIFFRACTION ASSEMBLY

Images; Left-*"Development of UT PA Inspection of PE pipe joints"* Troughton, Spicer and Hagglund. Right- <http://www.olympus-ims.com/en/applications/ultrasonic-tofd-butt-fusion/>

The orientation of butt fusion weld defects are typically perpendicular to the through wall direction but the defect edges can be at any orientation with respect to the outside surface. Diffraction amplitudes are particularly variable with respect to rotation relative to the scanning surface; hence TOFD is not necessarily a catch all technique for inspection and may need to be complemented by other UT techniques. Variations in material crystallinity through the section thickness of predominantly injection moulded fittings have been reported on occasion to provide reflections resulting in false positive readings.

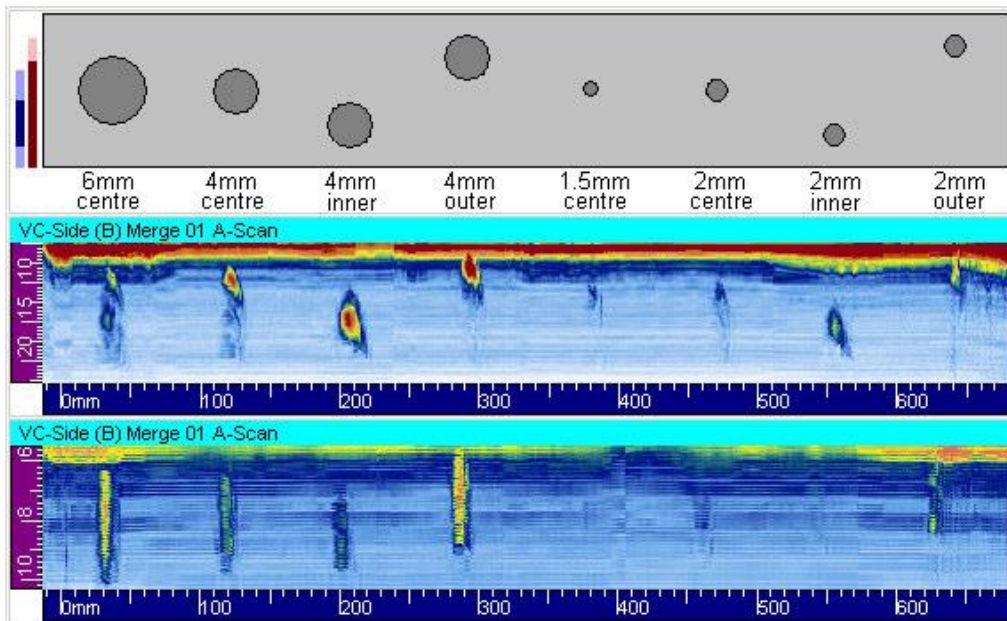

CIRCUMFERENTIAL SCANS ON A PIPE WITH FLAT BOTTOM HOLES USING SECTOR PULSE-ECHO & TANDEM

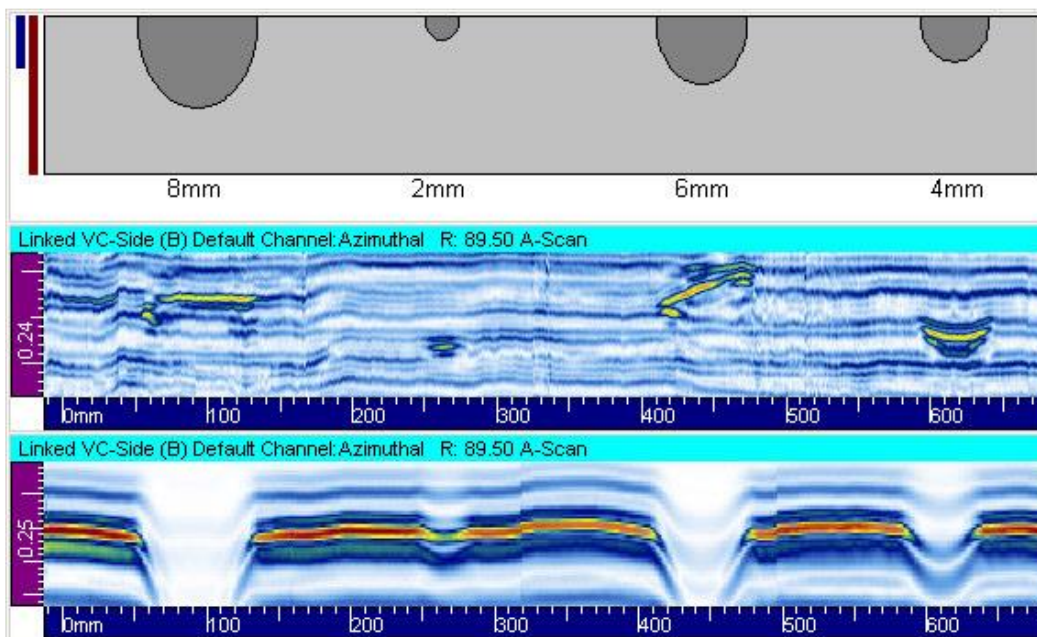

CIRCUMFERENTIAL SCANS ON A PIPE WITH SLOTS USING CREEPING WAVE AND ToFD

(Images taken from F. Hagglund, M. Spicer, M. Troughton "Development of Inspection Techniques for an Automated NDE Approach for Testing Welded Joints in Plastic PE Pipes,")

PHASED ARRAY (PAUT)

Has found application for inspecting both BF and EF welds (provided the coupling surface is suitable). Resolution of cold fusion, inclusion and void type defects has been reported. The limit of signal penetration whilst retaining the sensitivity required to detect small flaws is reported to be limited to a

wall thickness of around 100mm (*"Development of Inspection Techniques for an Automated NDE Approach for Testing Welded Joints in Plastic PE Pipes"* F. Haglund, M. Spicer, M. Troughton)

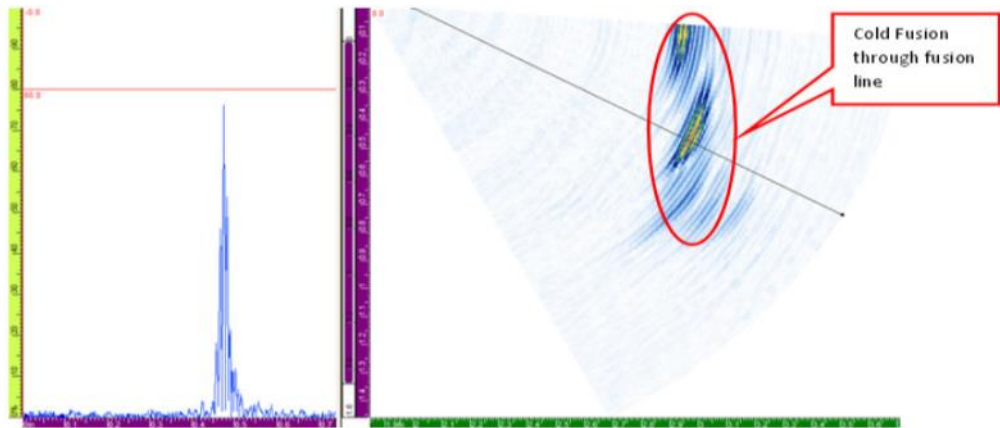

PA SCAN INDICATING COLD FUSION IN BF JOINT



CROSS-SECTIONAL VIEW FROM DESTRUCTIVE VERIFICATION OF COLD FUSION IN BF JOINT

(ICONE17-75859 *Ultrasonic Phased Array Examination of Butt Fusion Joints in High-Density C.* Frederick, D. Zimmerman & A.Porter)



RADIOGRAPH SHOWING REFLECTORS WITHIN PF PIPE SAMPLES

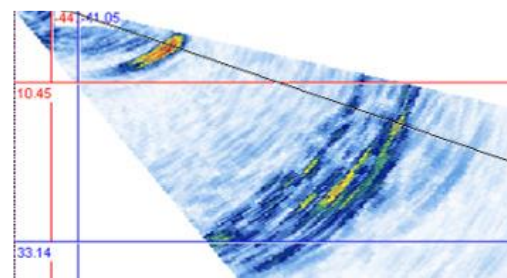

CORRESPONDING PAUT SPECULAR RESPONSES

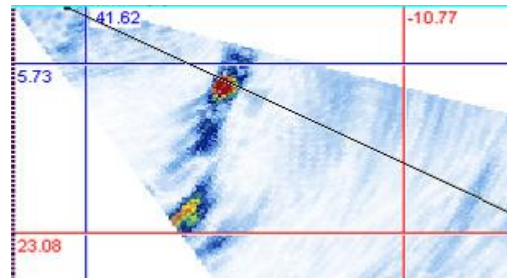
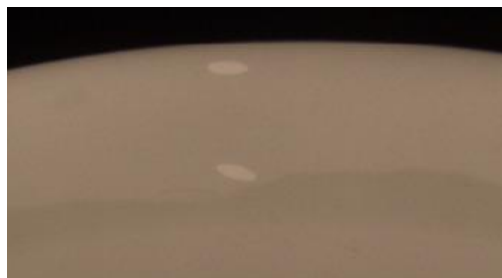

(Taken from *"Phased Array Inspection Solution for HDPE Butt Welds"* D MacLennan, J Allen, I G Pettigrew & C R Bird)

It has also been reported lack of fusion beneath EF wires, pipe misalignment and material degradation due to overheating of coupling may also be detected using this technique. The position of the Eigen Line (Heat Affected Zone) relative to the heating coils has been shown to be an indicator of heat input with the line moving further away with increasing heating time.

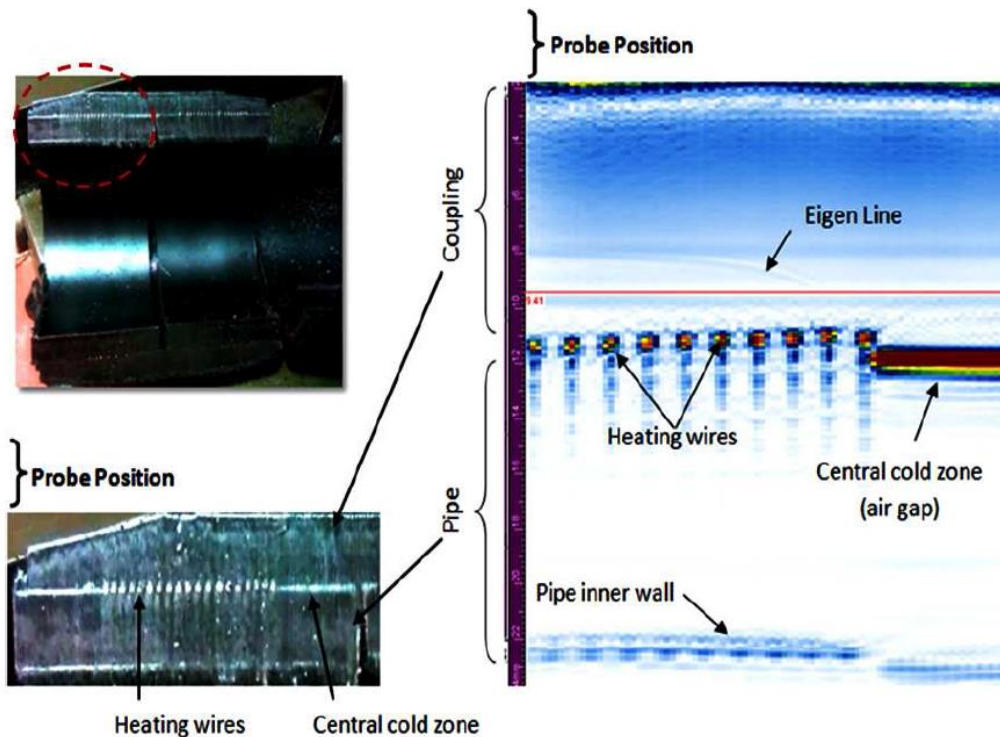

PAUT SPECULAR RESPONSE SCAN OF EF COUPLING HIGHLIGHTING PERTINENT REGIONS COMPARED AGAINST THE SAME CROSS-SECTION

"Ultrasonic Imaging of Electrofusion Welded Polyethylene Pipes Employed in Utilities Industry" Arjun Prakash TK, Richard L O'Leary & Anthony Gachagan, Centre for Ultrasonic Engineering, University of Strathclyde

MICROWAVE INTERFEROMETRY (MI)

Differentiates itself from UT in that microwave energy is not absorbed or dispersed within dielectric materials and is able to pass through multiple layers of material. MI works by utilising a probe containing a transducer to bathe the test area with low voltage microwave energy and a receiver to measure the resulting field strength of the reflected energy mixed with a portion of the transmitted energy of the outgoing signal as the probe is moved across the inspection surface. An image is generated using the field strength mapped to the probe's location on the inspected part and digitally saved for review. Detectable signals are reflected at interfaces where the dielectric constant varies (eg, cracks, delaminations/cold fusion welds, holes/porosity, inclusions/contamination/ impurities, etc). The ability to overlay successive scans over time allows determination of the growth rate of a defect.

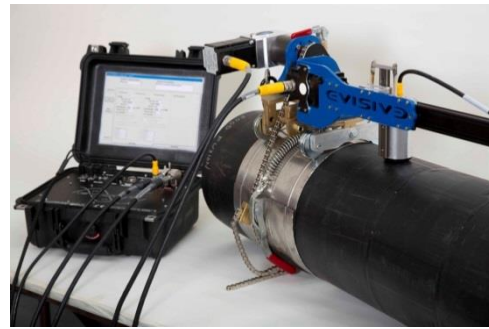
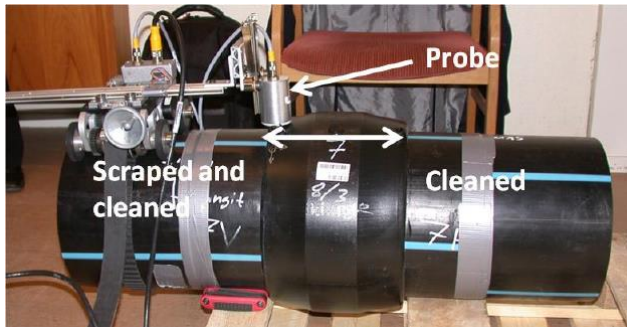

MICROWAVE EF AND BF WELD SCANNING ARRANGEMENTS

(Photos courtesy of Evisive)

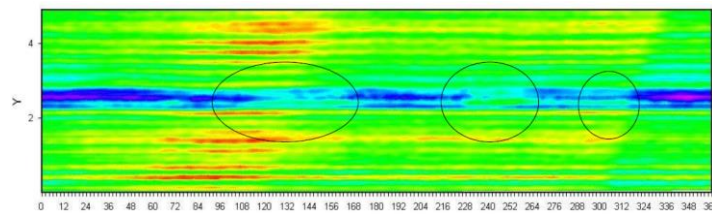
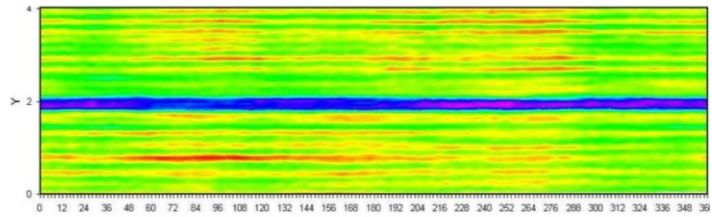

MICROWAVE EXAMPLE OUTPUT BUTT WELD SCANS WITH GOOD WELD AT TOP AND WELD CONTAINING FUSION DEFECTS ON THE BOTTOM

(Photos courtesy of Evisive)

MI manufacturers currently provide guidance for applying the technique to detect porosity, contamination and poor/cold fusion within butt fusion and electro-fusion welds, including guidance for comparative acceptance criteria based on sound weld scans. Operation of the equipment and interpretation of scans requires competent trained personnel. The technique has also demonstrated the identification of common faults with electrofusion joints such as contamination, misalignment and melts flow into cold zones.

RADIOGRAPHY

Relies on changes in bulk density to detect features or anomalies within a specimen. Radiography has been used to supplement the visual inspection of larger diameter polyethylene pipe. Inspection of electrofusion joints can readily determine tolerance or assembly issues such as misalignment, pipe end squareness, insertion distance (lack of fusion) or highlight coil coupling issues.

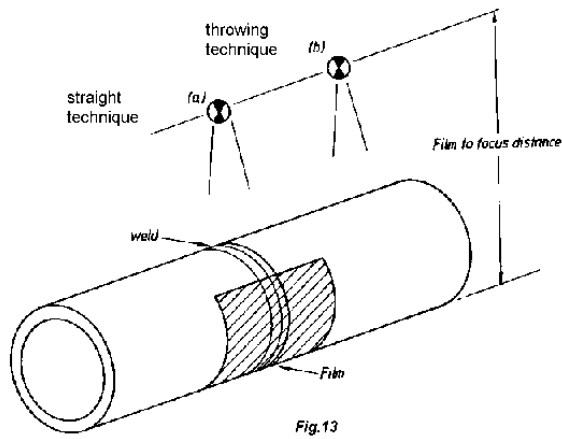
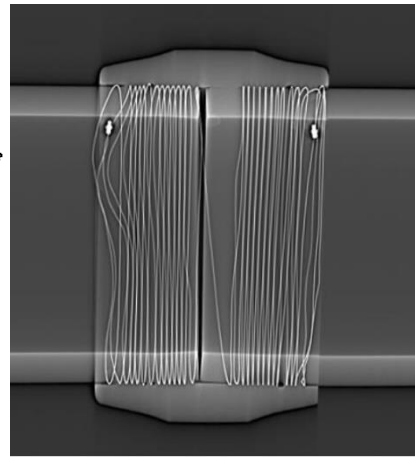

Fig.13

ULTRASONIC AND RADIOGRAPHIC NDT OF BUTT AND ELECTROFUSION WELDS IN POLYETHYLENE PIPE

Plastic Pipes IX, [I.J. Munns and G.A. Georgiou](#)
[TWI, Abington UK](#)



SURFACE ANALYSIS OF POLYETHYLENE PIPES AND FAILURE CHARACTERIZATION OF ELECTROFUSION JOINTS

Lukas Boge; Emil Hjartfors

DIGITAL RADIOGRAPHY

Digital radiography systems acquire more information than film due to greater "sensitivity" and "latitude". Application is the same as for film with the added ability for the user to "tint roll" through various density ranges to highlight regions of interest (e.g. voids, inclusions or fusion zones). A number of proprietary imaging solutions have been developed which avoid the fogging caused by x-ray scatter to produce raw data with a higher signal-to-noise ratio which facilitates evaluation of critical regions.

PIPA wishes to acknowledge and thank all our Technical Committee members and Industry Consultants for their contribution, expertise, and assistance in the development of this technical document.

DISCLAIMER - In formulating this document PIPA has relied upon the advice of its members and, where appropriate, independent testing. Notwithstanding, users of the document are advised to seek their own independent advice and, where appropriate, to conduct their own testing and assessment of matters contained in the document and to not rely solely on the document in relation to any matter that may risk loss or damage. PIPA gives no warranty concerning the correctness or accuracy of the information, opinions and recommendations contained in the document. Users of the document are advised that their reliance on any matter contained in the document is at their own risk.